









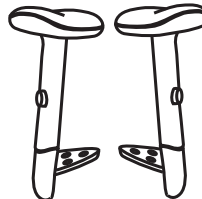
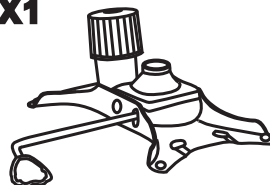
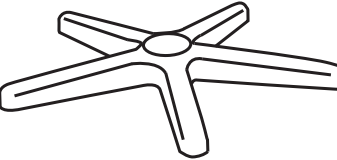

<p><b>(1)X1</b></p> 	<p><b>(7)X5</b></p> 
<p><b>(2)X1</b></p> 	<p><b>(8)X1</b></p> 
<p><b>(3)X1(L)X1(R)</b></p> 	<p><b>(9)X4</b></p> 
<p><b>(4)X1</b></p> 	<p><b>(10)X4</b></p> 
<p><b>(5)X1</b></p> 	<p><b>(11)X6</b></p> 
<p><b>(6)X1</b></p> 	<p><b>(12)X1</b></p> 